

2" USALIGHT LED LINE VOLTAGE RECESSED HOUSING

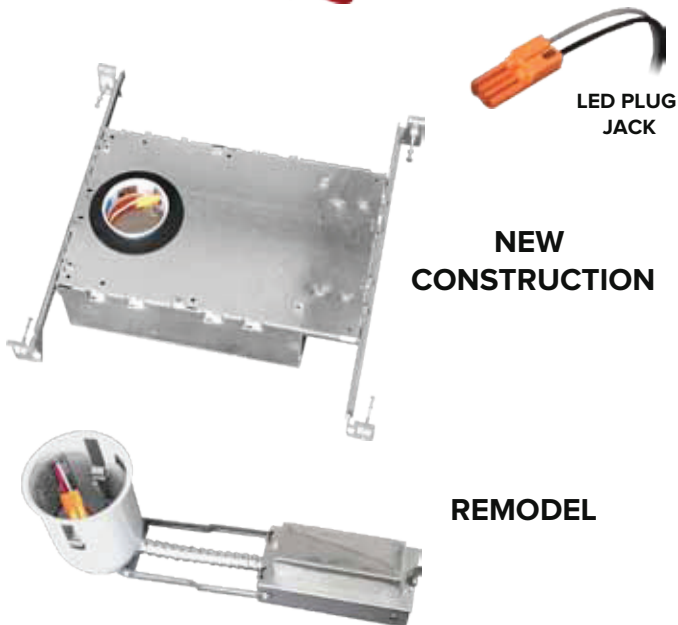

Specifications

- LED engine mounted
- Accessible to LED engine from below the ceiling
- ≥ 80 or ≥ 90 CRI
- 2700K, 3000K, 4000K, 5000K available
- Accommodates 120 volts AC at 60Hz
- Dimmable with most standard incandescent, magnetic low voltage and electronic low voltage dimmers
- 120-277V available (Dimmable at 120V only)

Trim

- Smooth / Baffle trims.
- Square Smooth / Square Baffle trims
- Adjustable Gimbal / Adjustable Square Gimbal trims

Listings

- cUL us Listed
- Energy star qualified
- Wet locations (Not suitable for coastal/salt water area)
- Damp locations



US-102ICAT-LED | US-102-R-LED

SPECIFICATIONS | US-102ICAT-LED

MATERIAL	GALVANIZED STEEL
BAR HANGERS	12"-25.5" JOIST SPAN
ADJUSTABLE	VERTICAL
KNOCKOUTS	(1) 1 1/8" (3) 7/8" (1) 1/2"
RECESSED SIZE	2 INCH
LENGTH	12"
WIDTH	7.675"
HEIGHT	4.5"
INSULATION COMPLIANT (IC)	YES

SPECIFICATIONS | US-102-R-LED

MATERIAL	GALVANIZED STEEL
BAR HANGERS	NONE
ADJUSTABLE	VERTICAL
KNOCKOUTS	(2) 1/2"
RECESSED SIZE	2 INCH
LENGTH	9.75"
WIDTH	2.875"
HEIGHT	3.5"
INSULATION COMPLIANT (IC)	NO

DIMENSIONS:

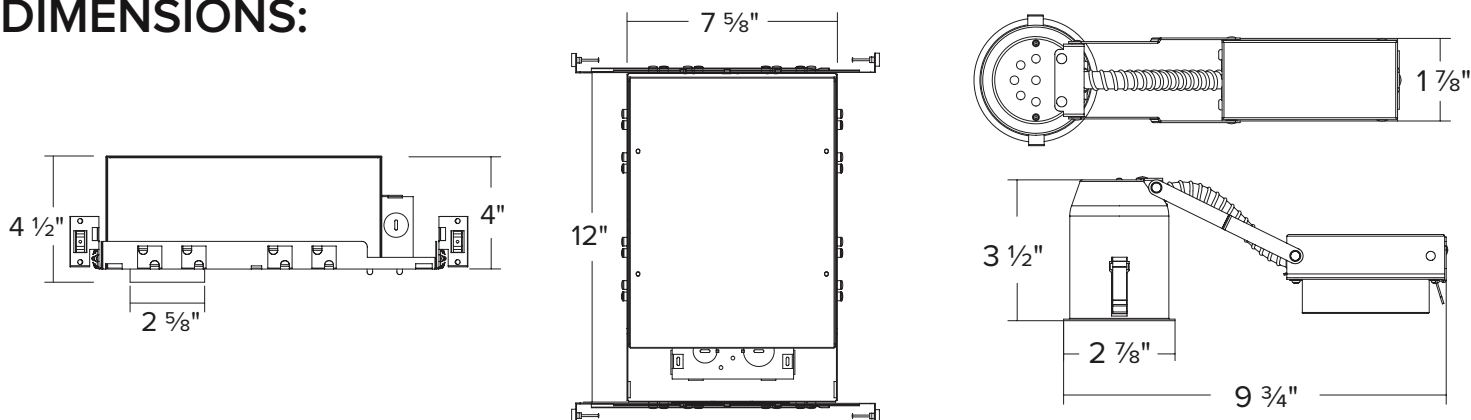

2" USALIGHT LED LINE VOLTAGE RECESSED DOWN LIGHTS

US-LM200W Smooth

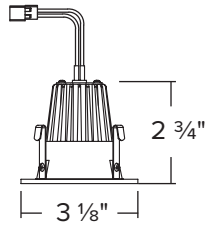

US-LM203W Baffle

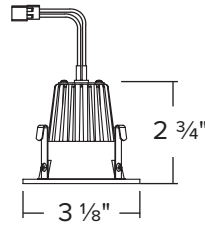

PERFORMANCE DATA

Input Voltage	120V
Input Power	9W
Frequency	50 / 60Hz
Operation temp	-30C ~ 40C (-22F ~ 104F)
Lumens	640
CRI	≥ 90

US-LM240W Square Smooth

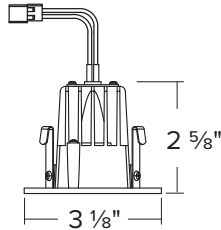

US-LM243W Square Baffle

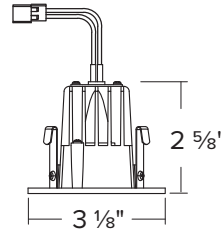

PERFORMANCE DATA

Input Voltage	120V
Input Power	9W
Frequency	50 / 60Hz
Operation temp	-30C ~ 40C (-22F ~ 104F)
Lumens	630
CRI	≥ 90

US-LM207W Adj. Gimbal

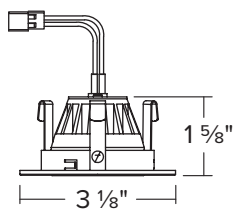

US-LM247W Adj. Square Gimbal

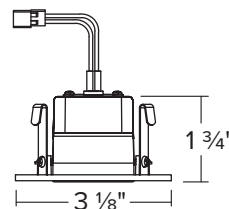

PERFORMANCE DATA

Input Voltage	120V
Input Power	LT207 - 9W LT247 - 9W
Frequency	50 / 60Hz
Operation temp	-30C ~ 40C (-22F ~ 104F)
Lumens	LT207 - 680 LT247 - 670
CRI	≥ 90